

NV-22

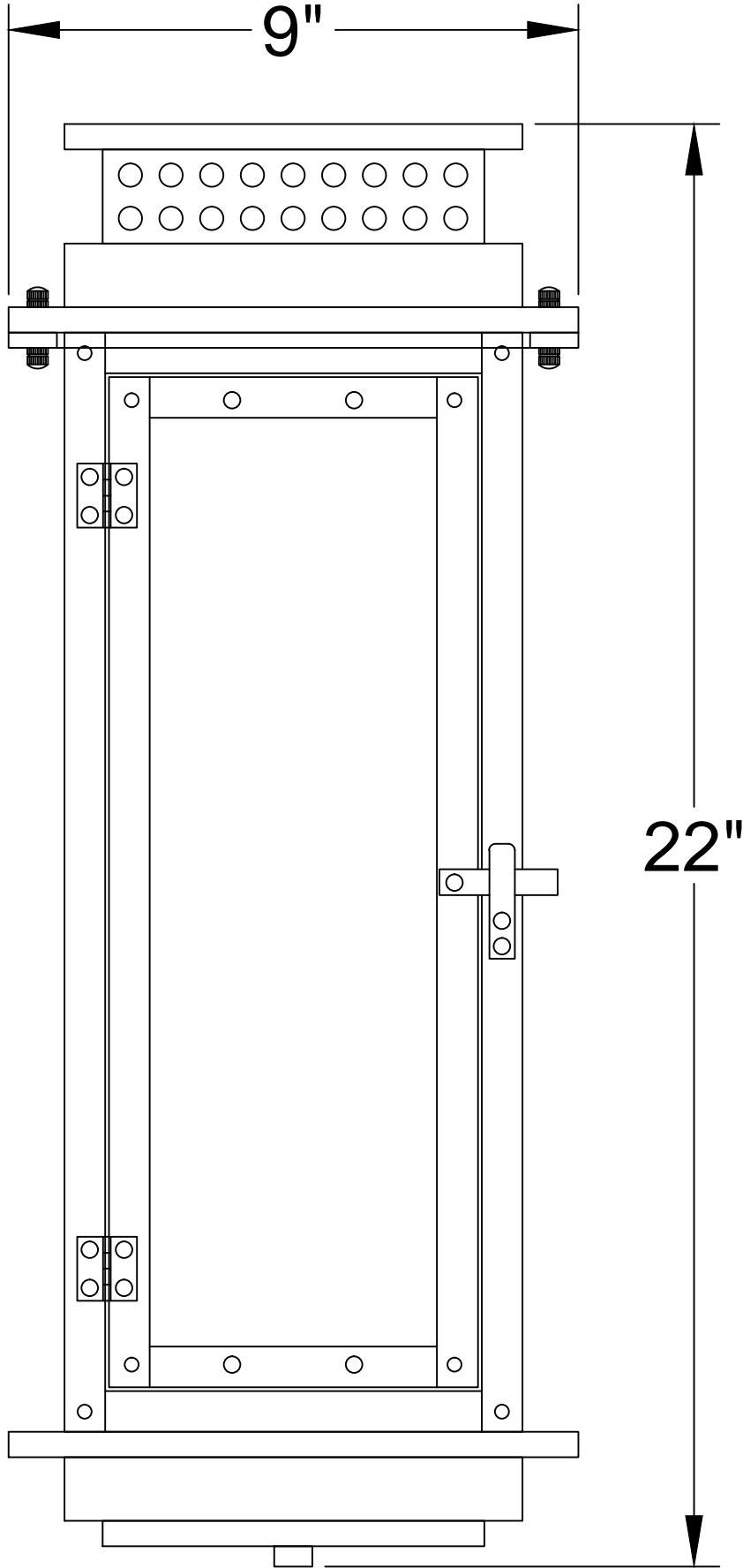

Front

NV-22

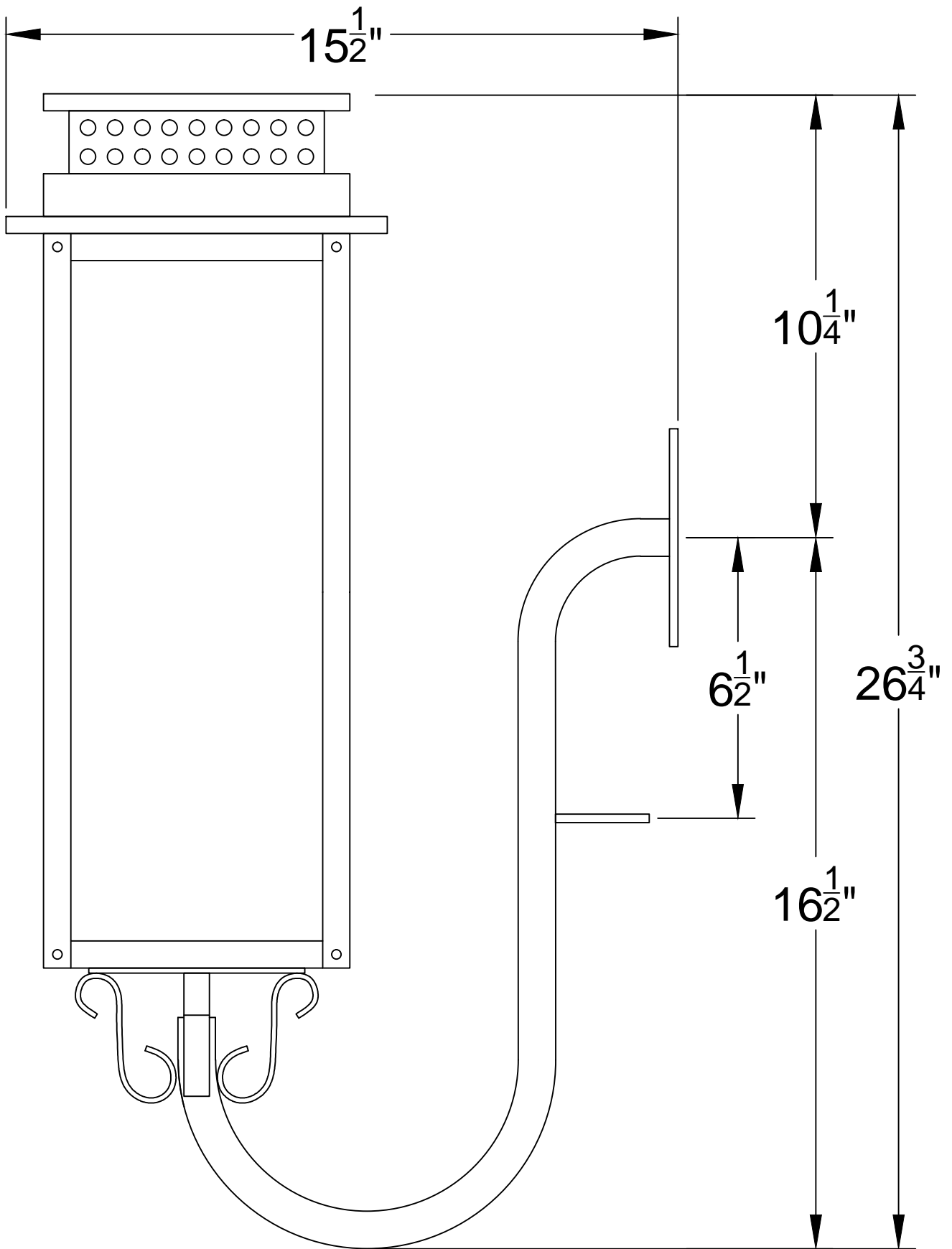

GN

NV-22

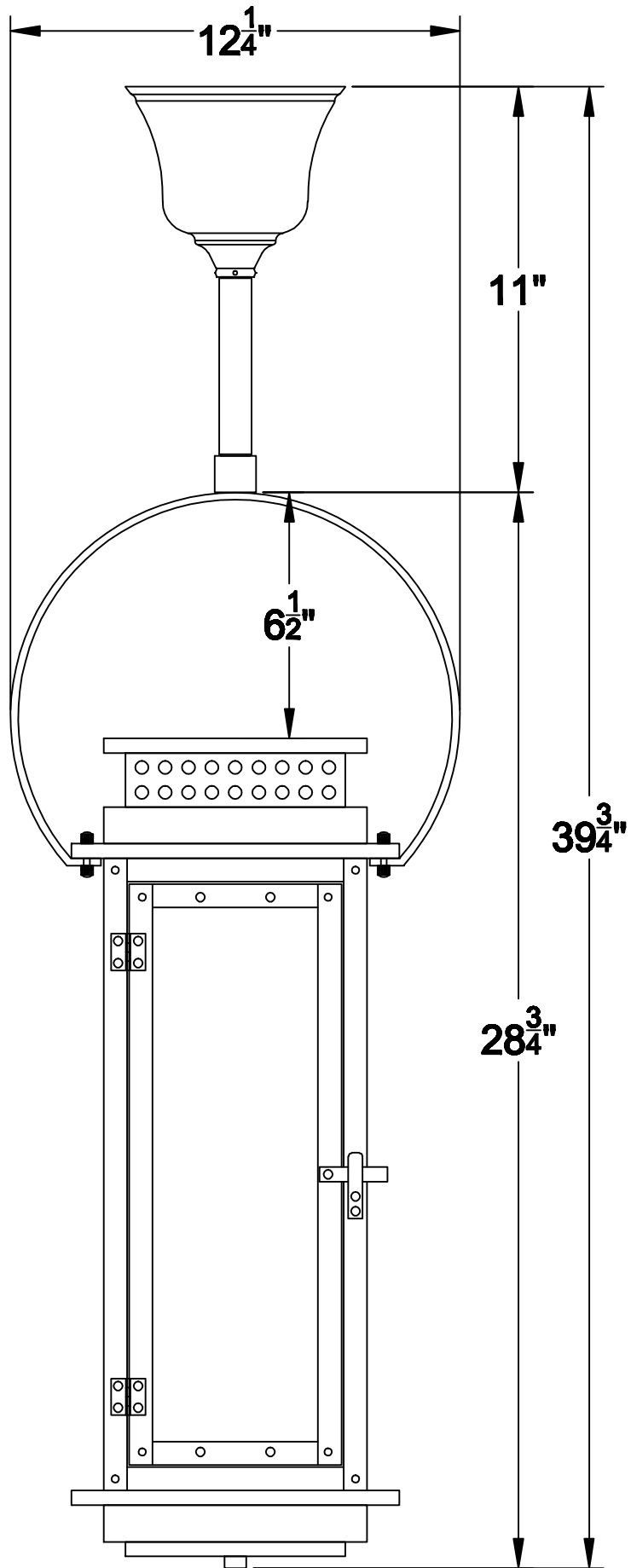

HY-1

NV-22

60¹/₄"

22"

MU

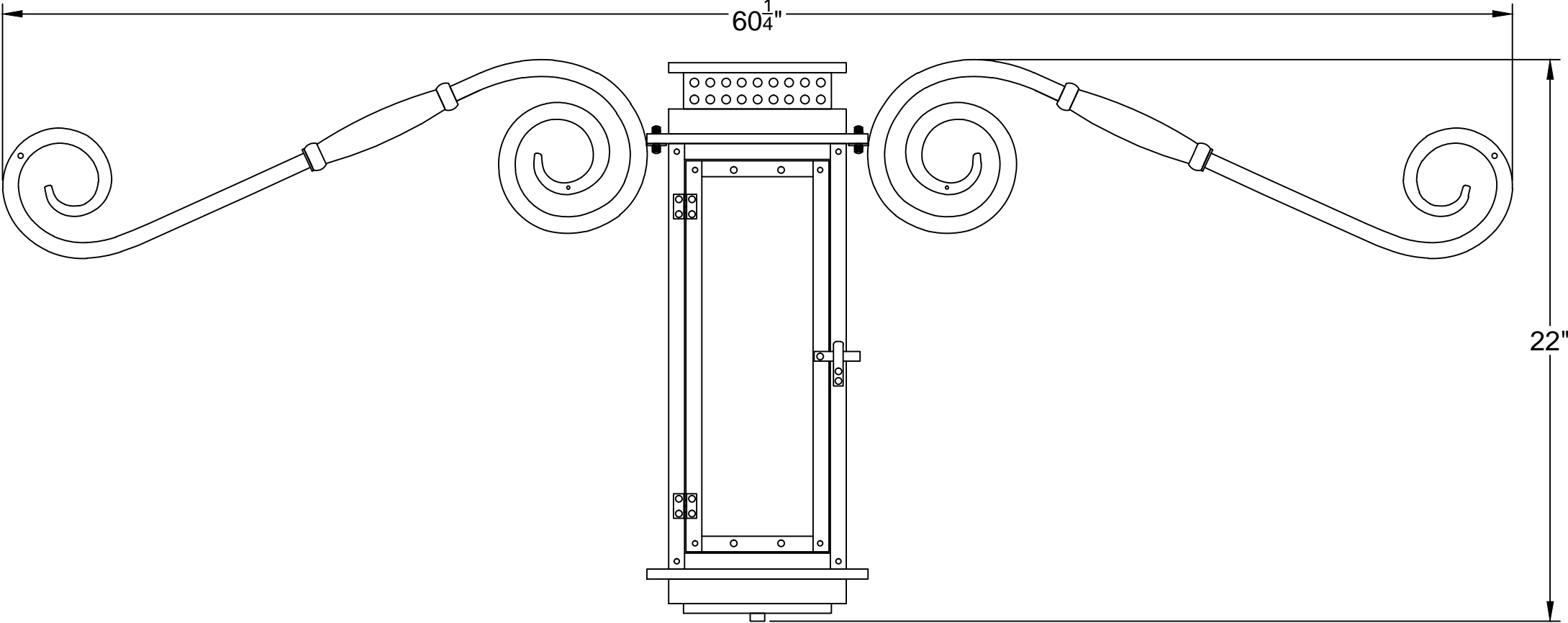

NV-22

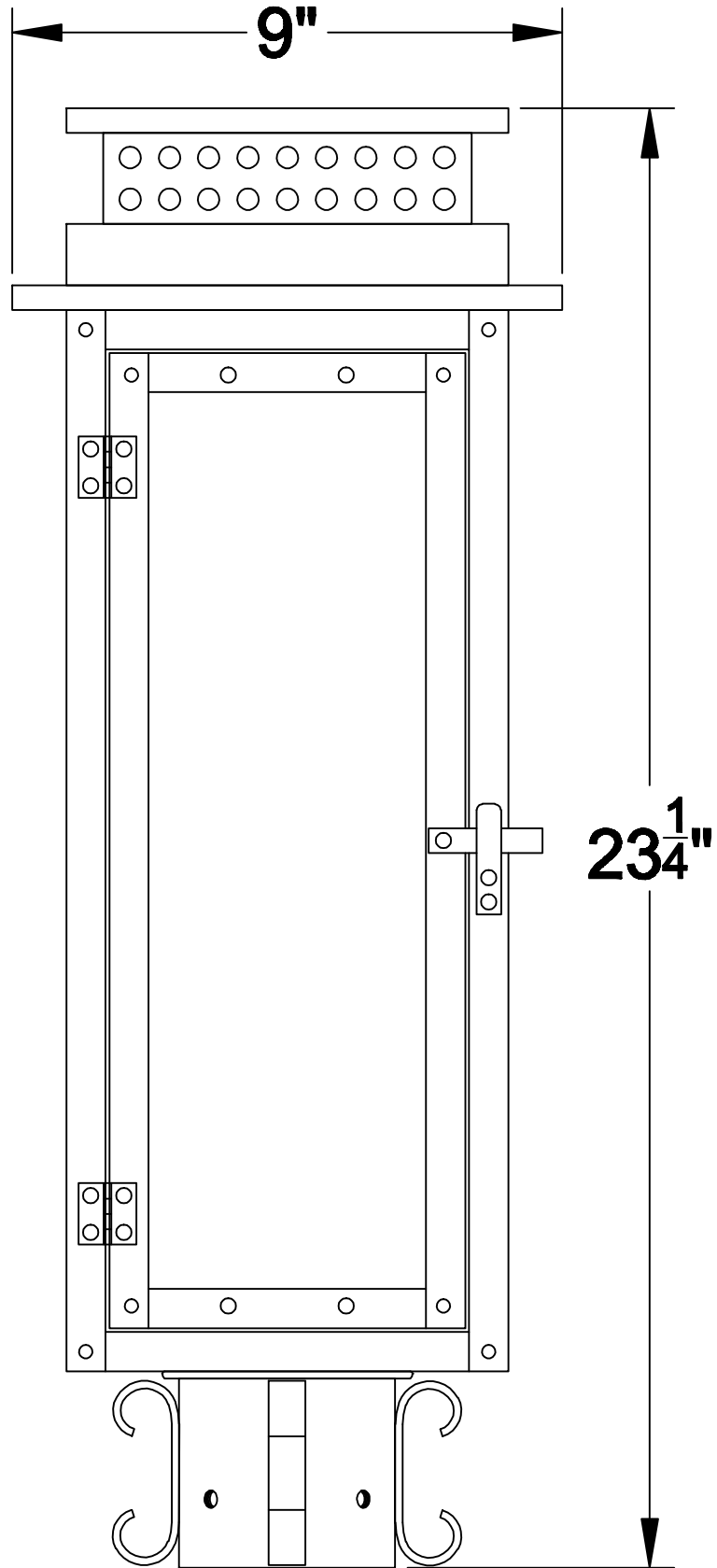

PM

NV-22

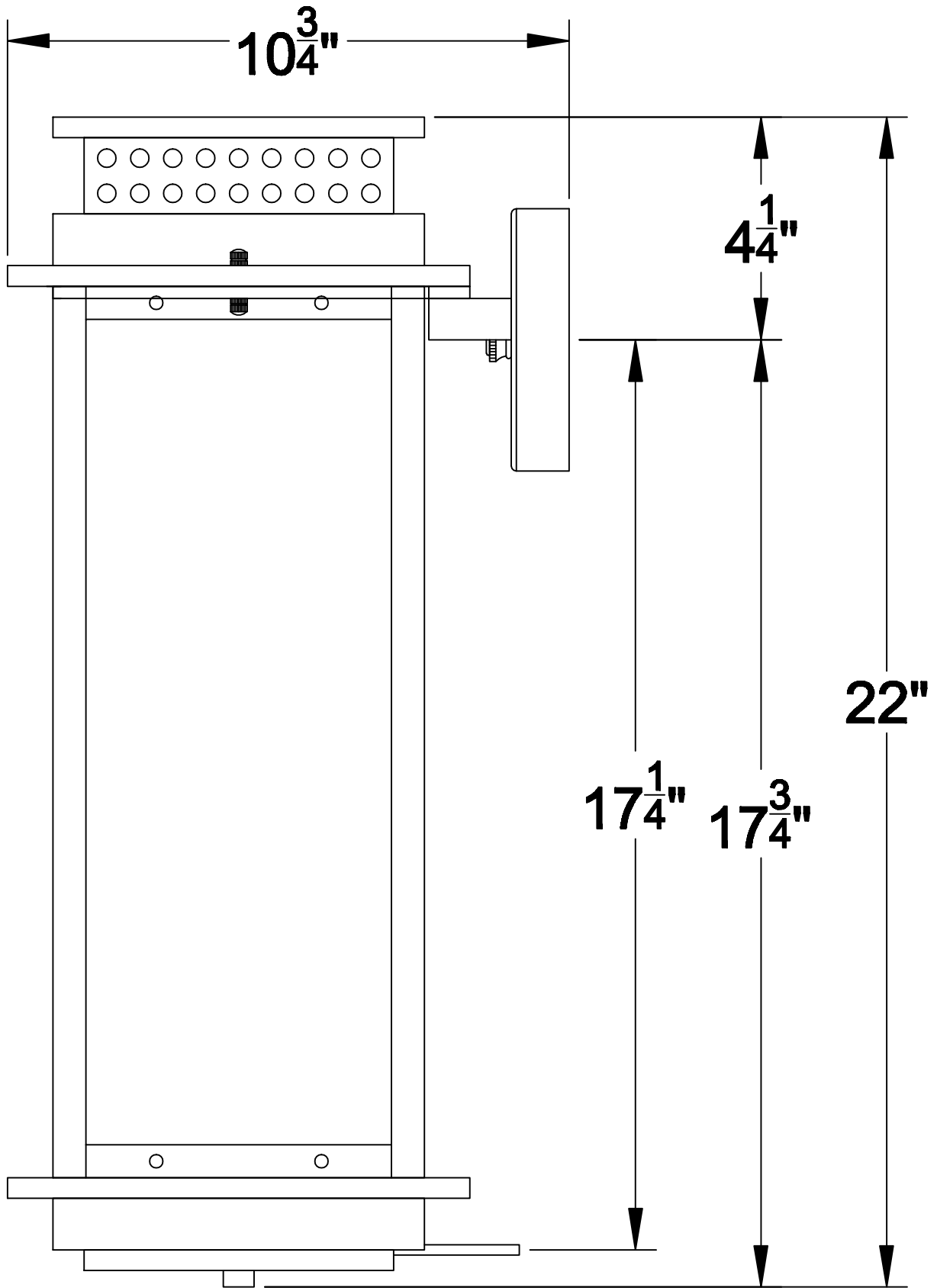

Side

NV-22

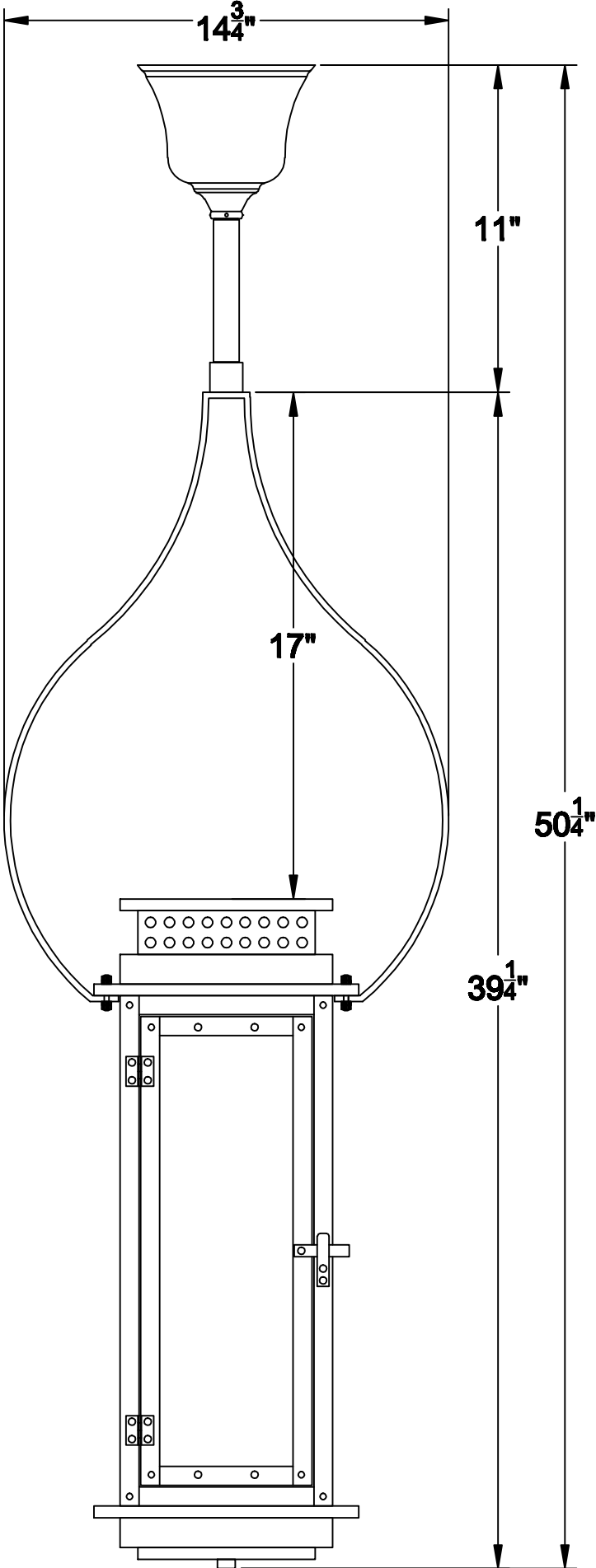

TY-1