

CT-35

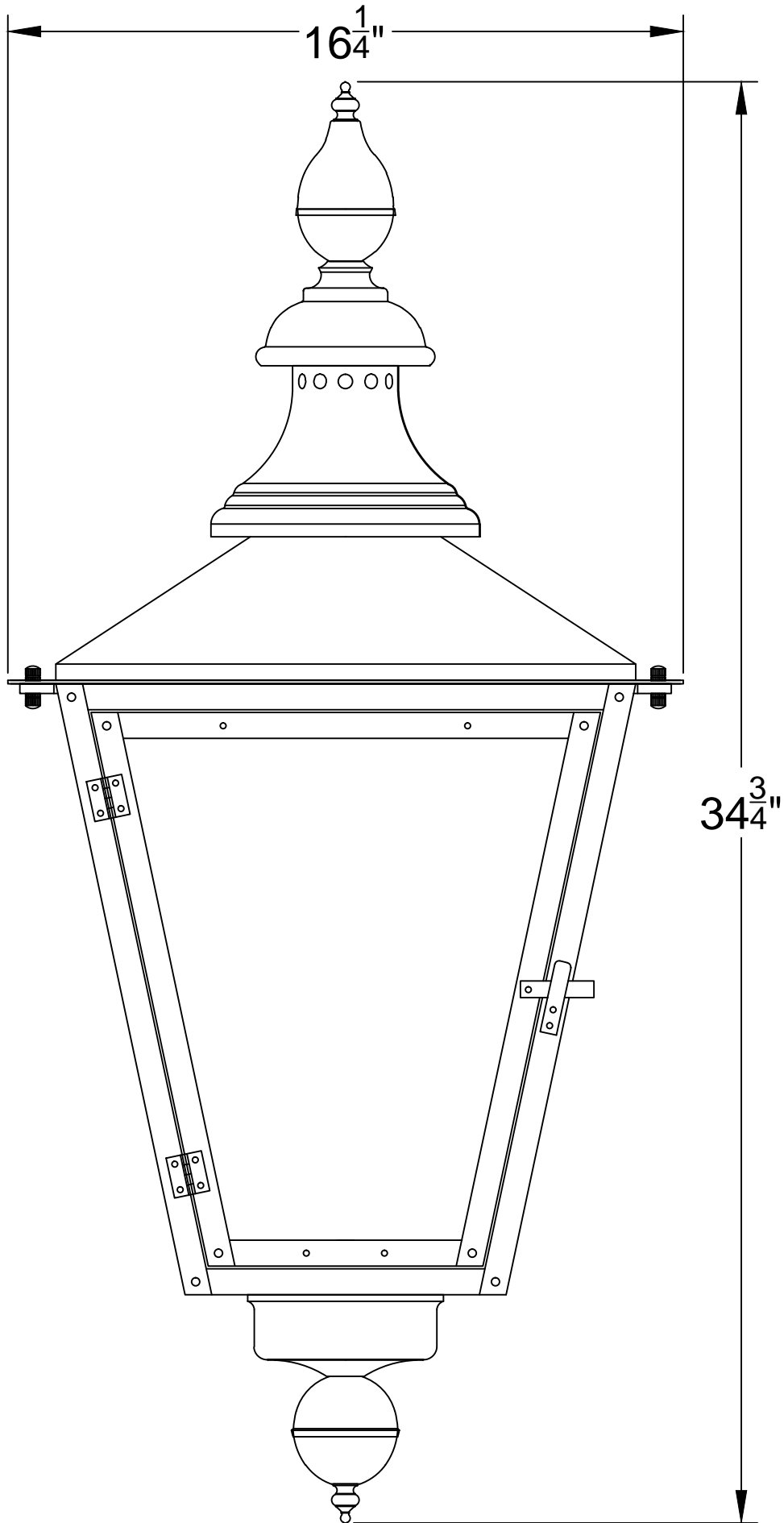

Front

CT-35

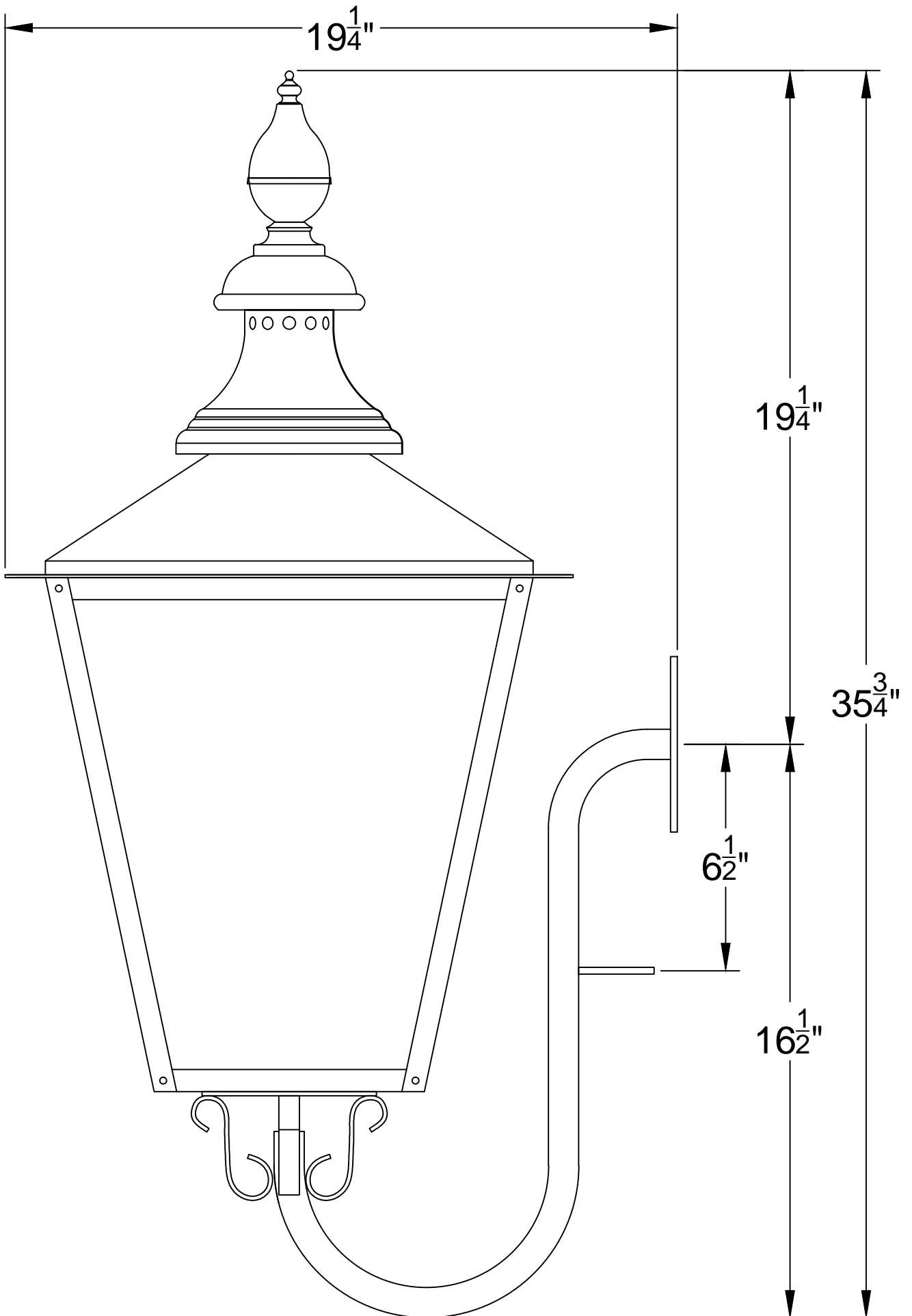

GN

CT-35

67 $\frac{3}{4}$ "

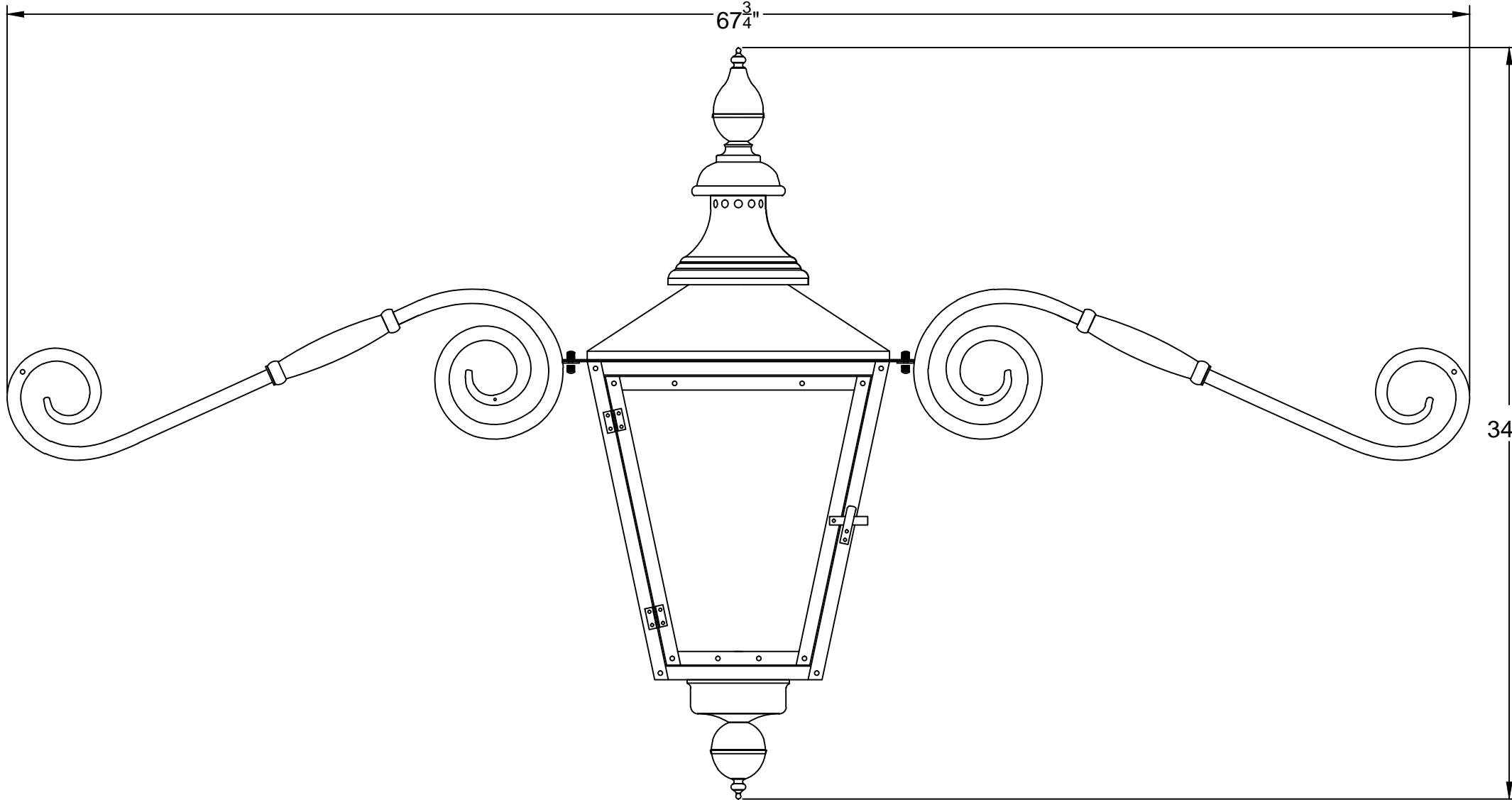

34 $\frac{3}{4}$ "

MU

CT-35

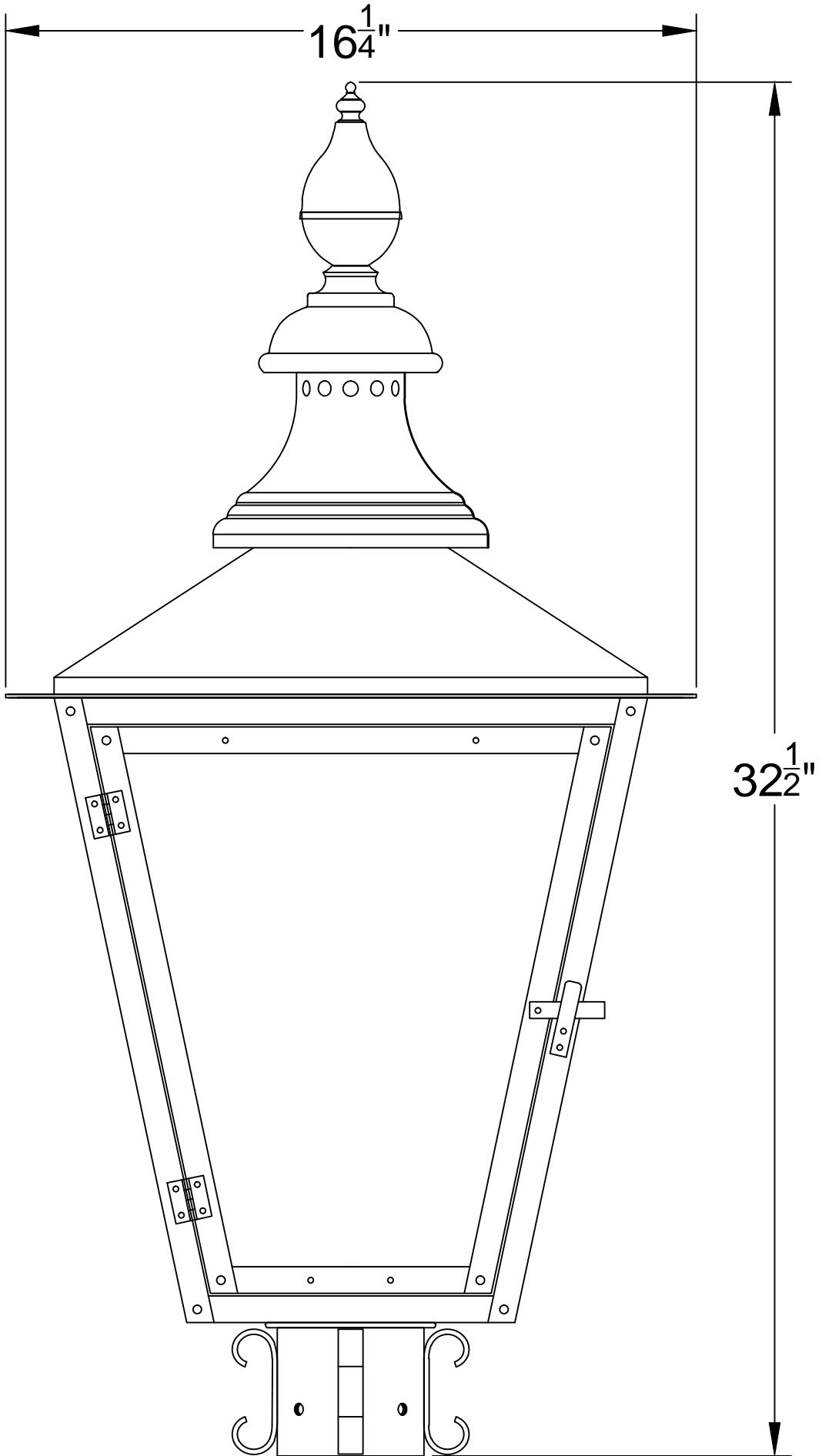

PM

CT-35

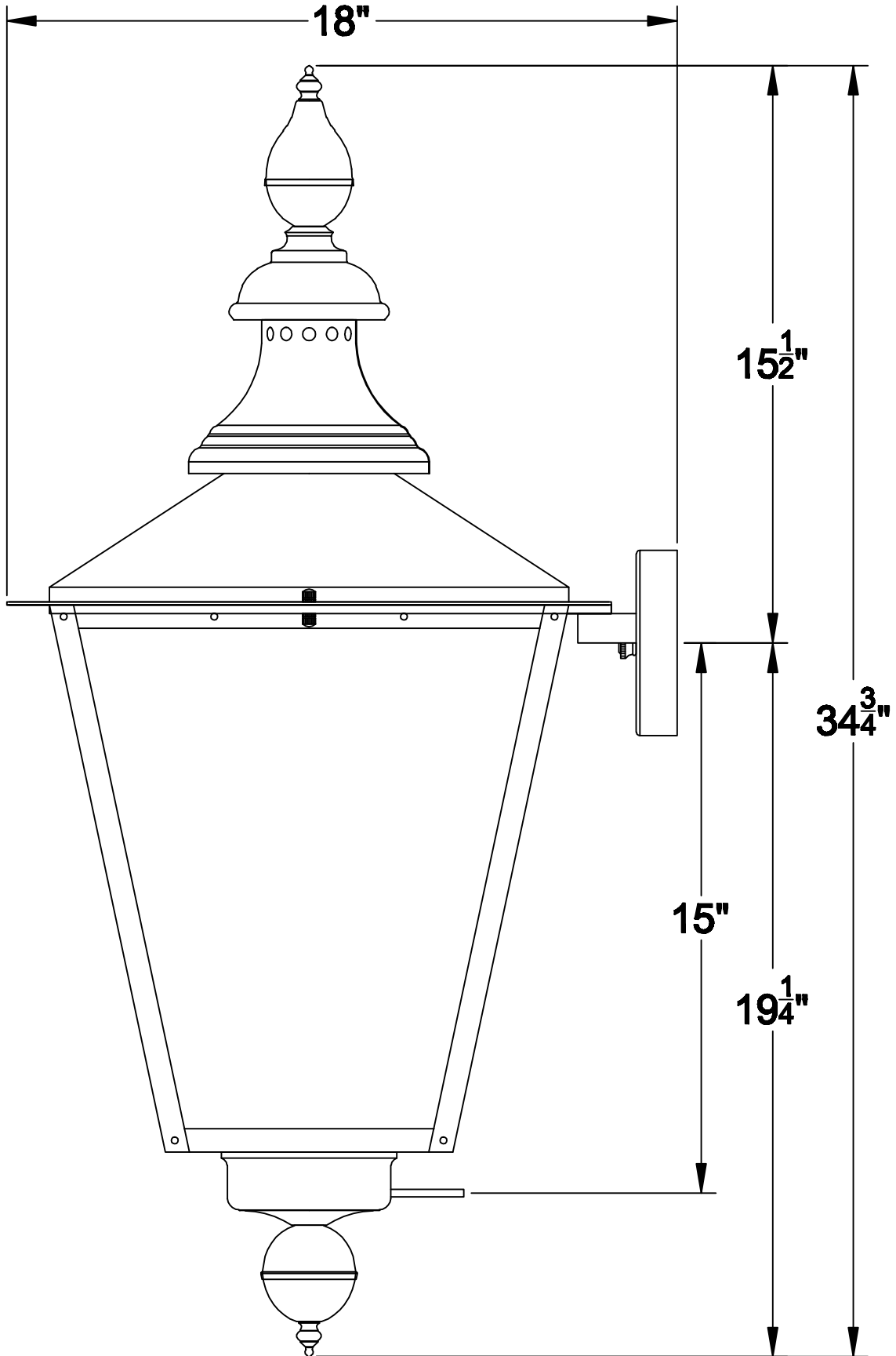

Side

CT-35

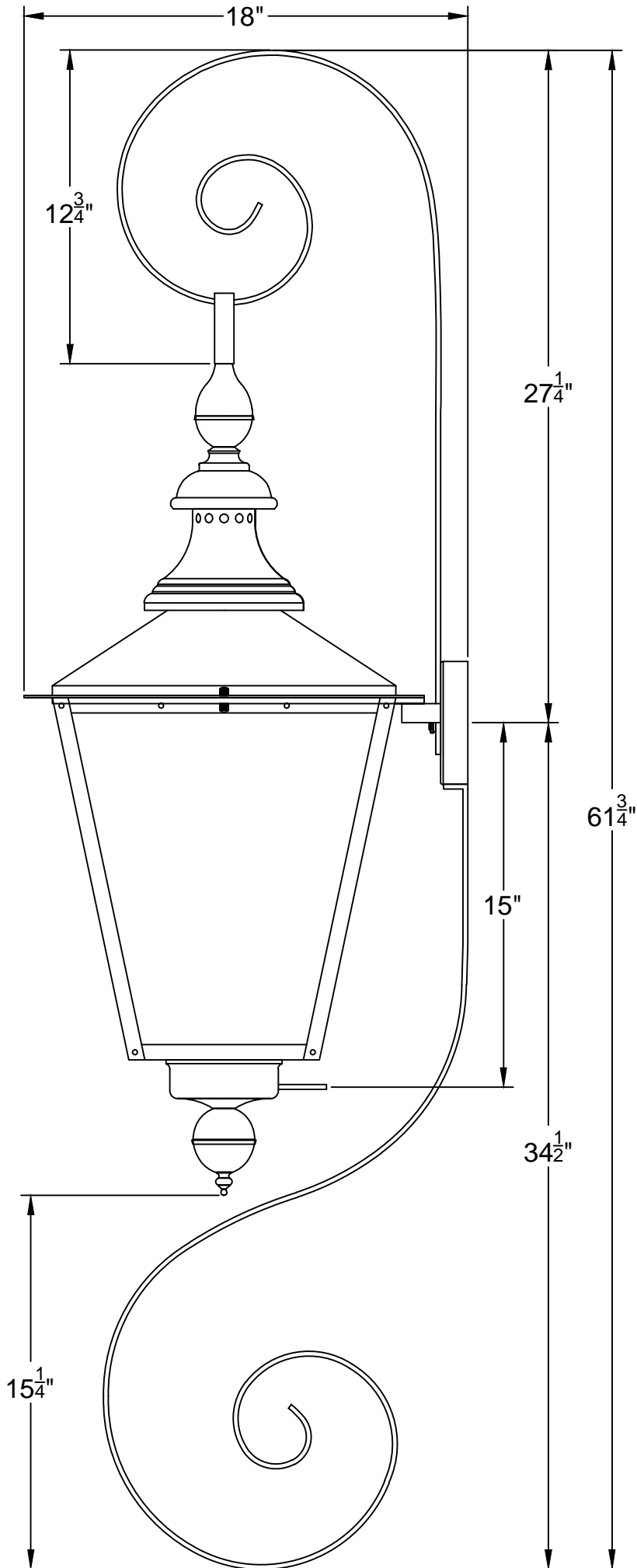

TS-4 BS-3

CT-35

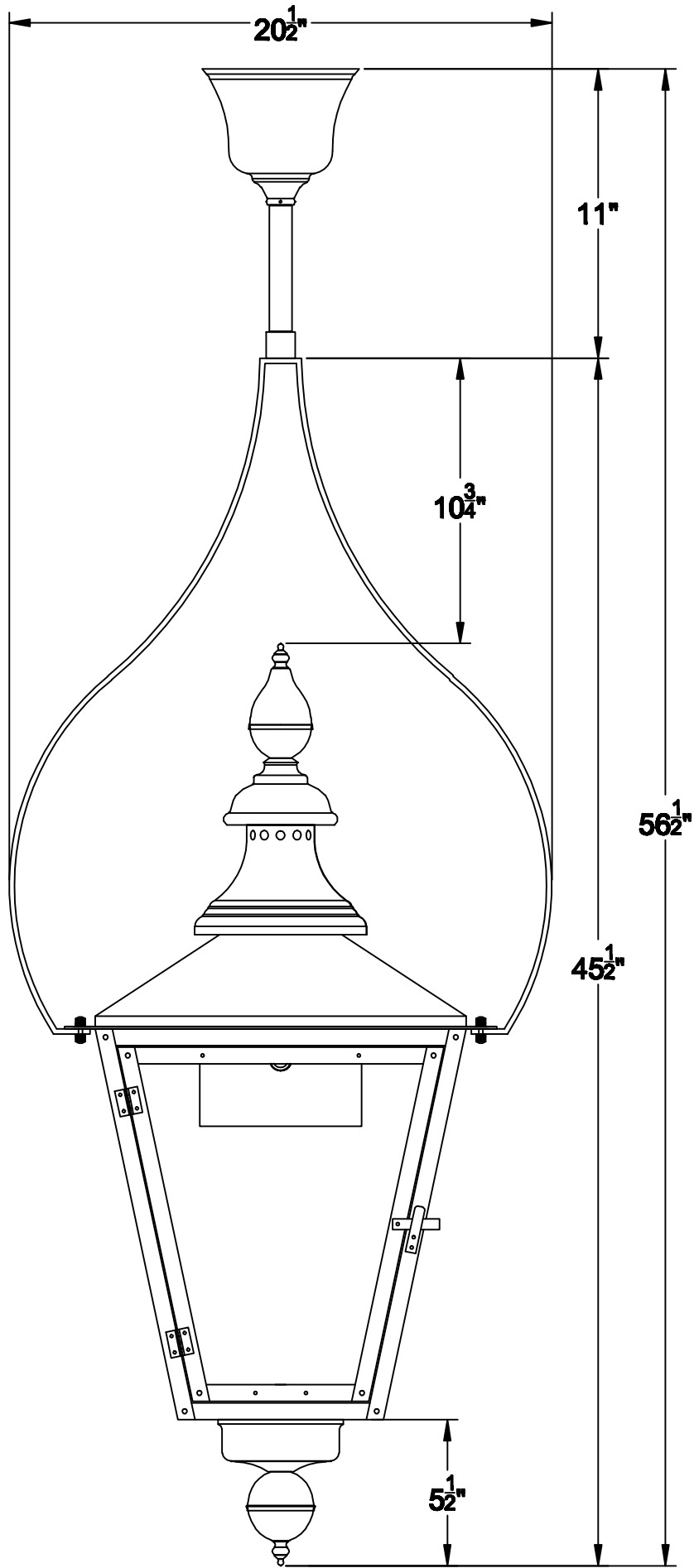

TY-3