

BB-19

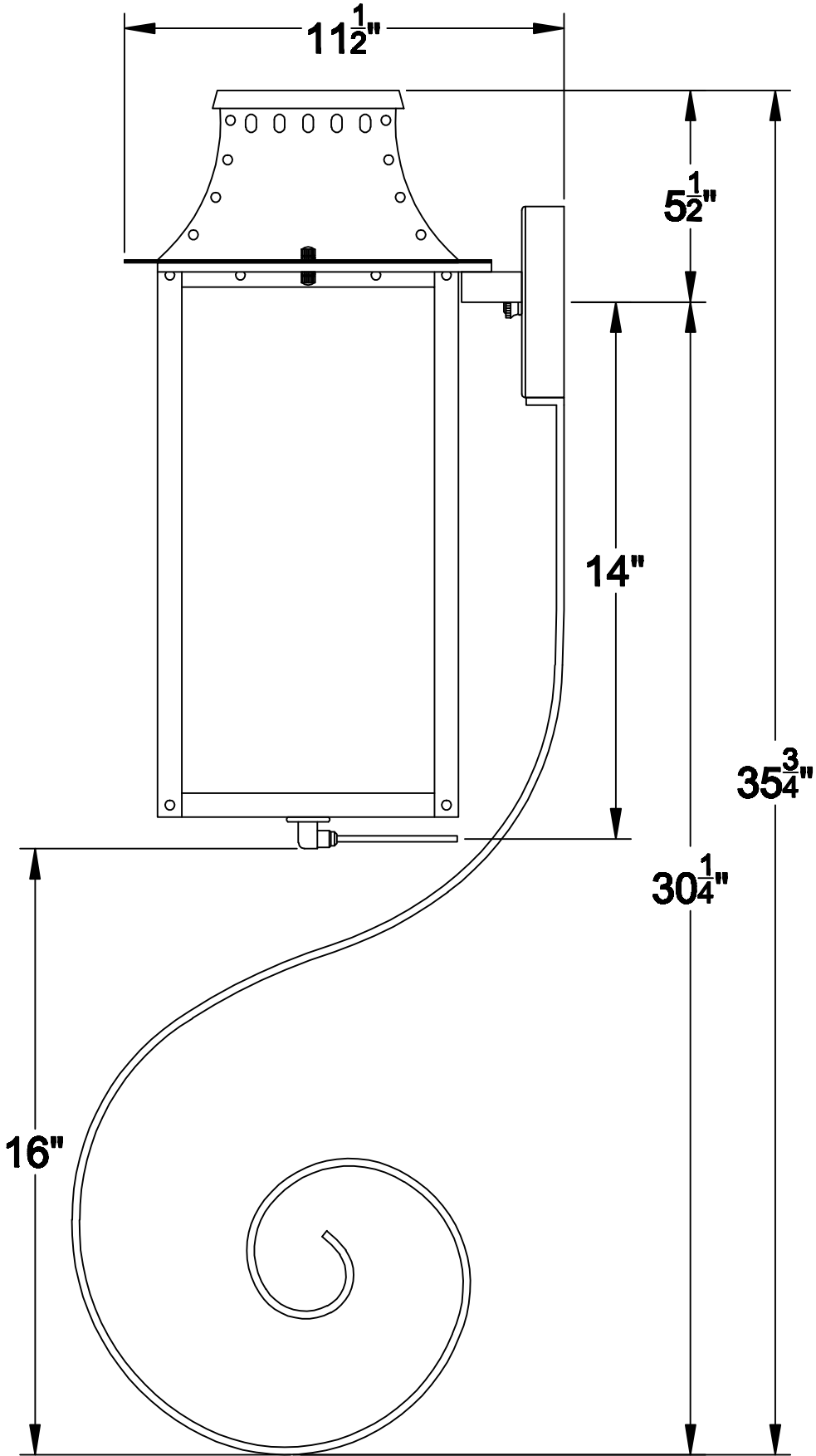

BS-2

BB-19

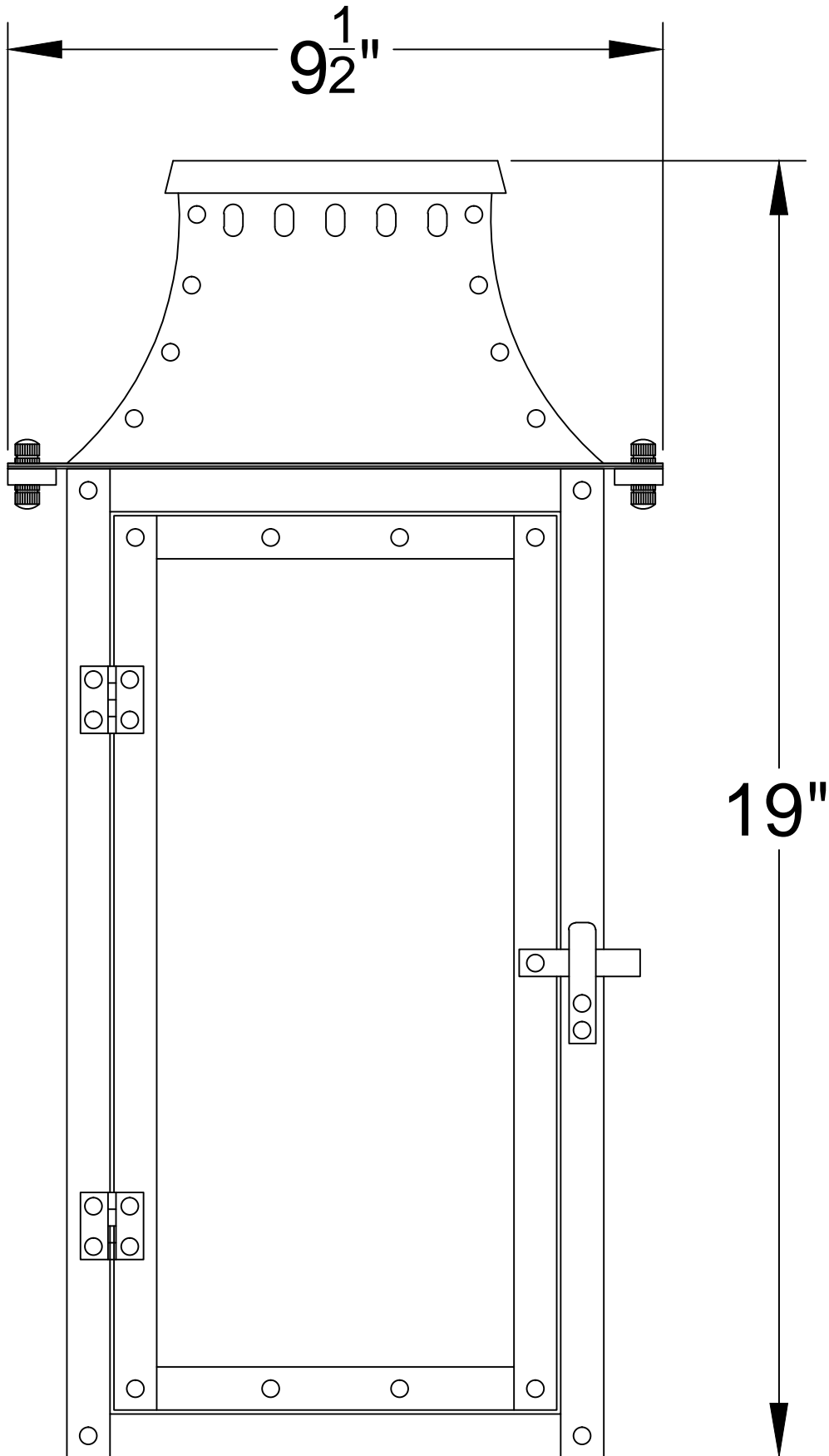

Front

BB-19

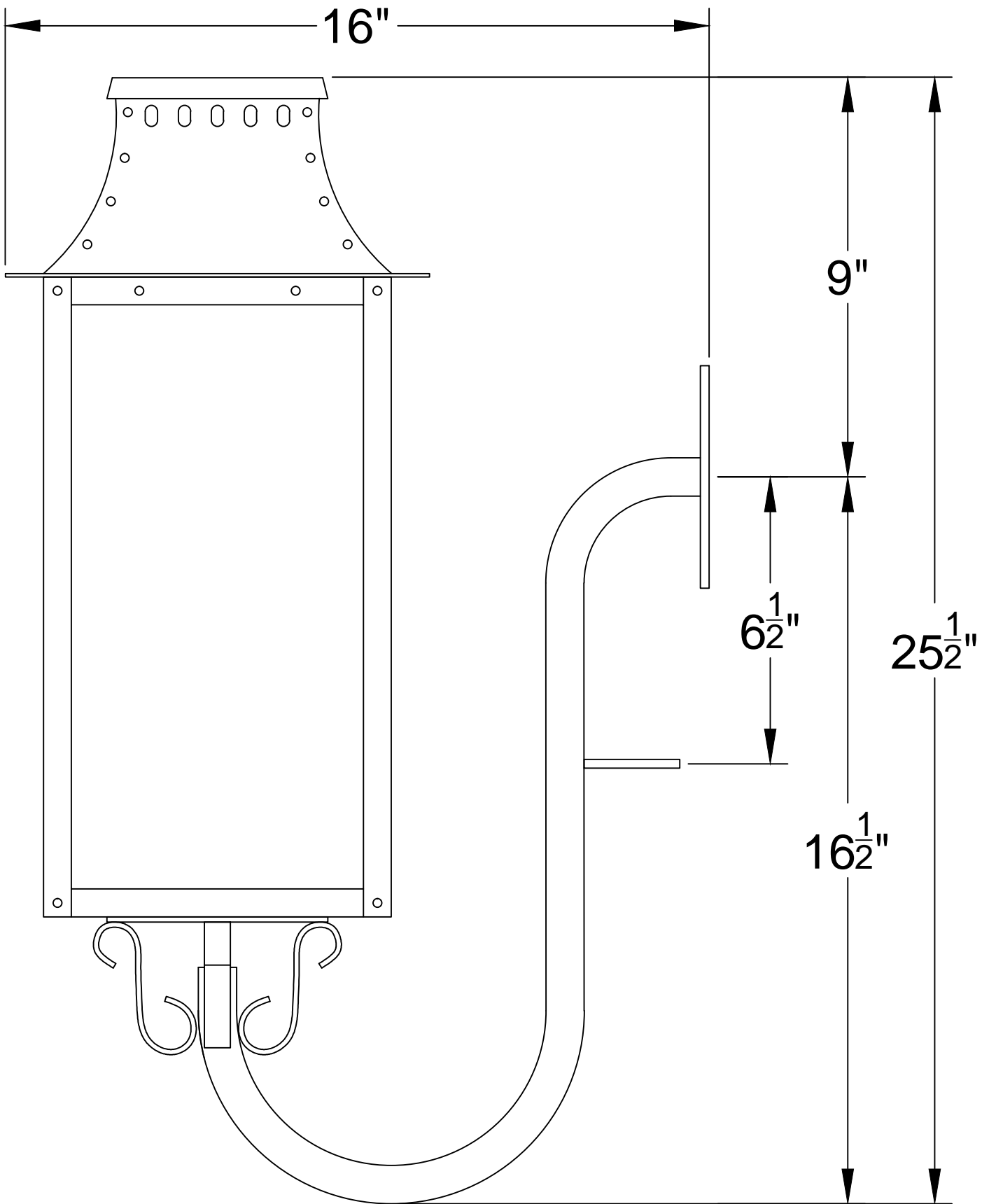

GN

BB-19

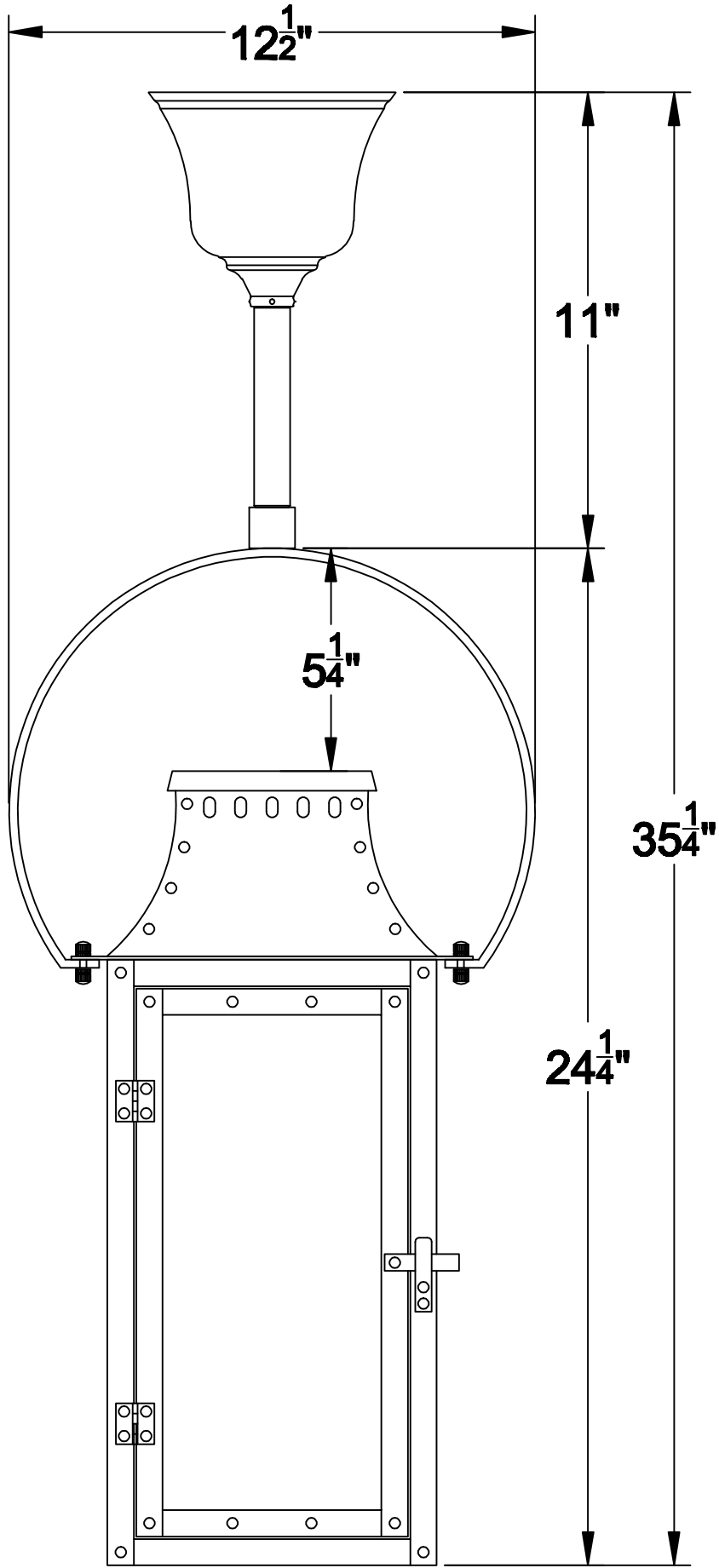

HY-1

BB-19

61 $\frac{1}{4}$ "

19"

MU

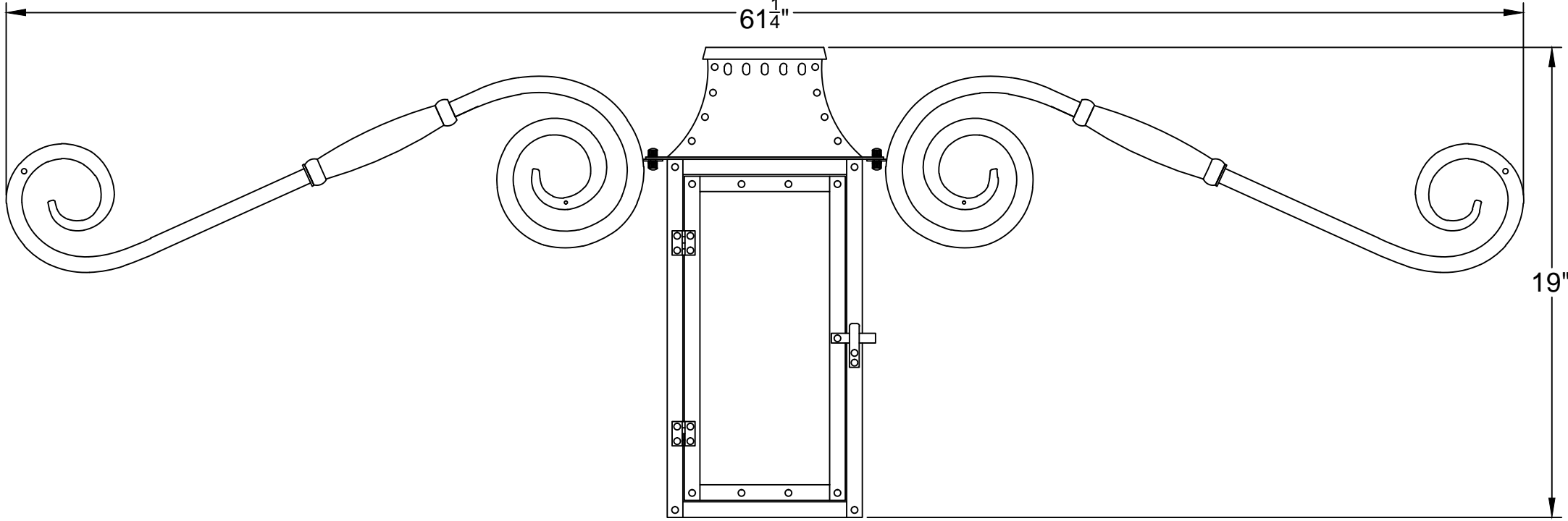

BB-19

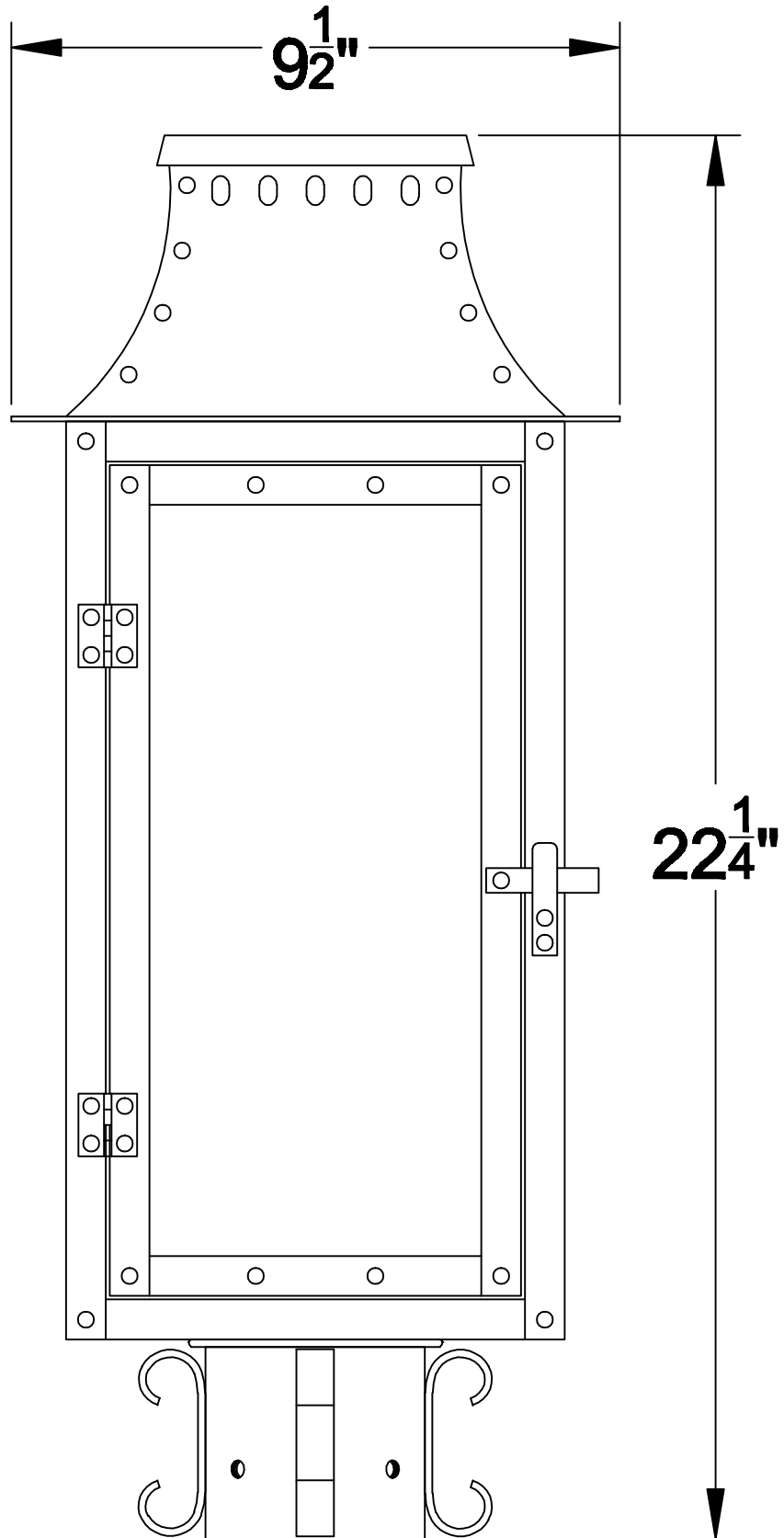

PM

BB-19

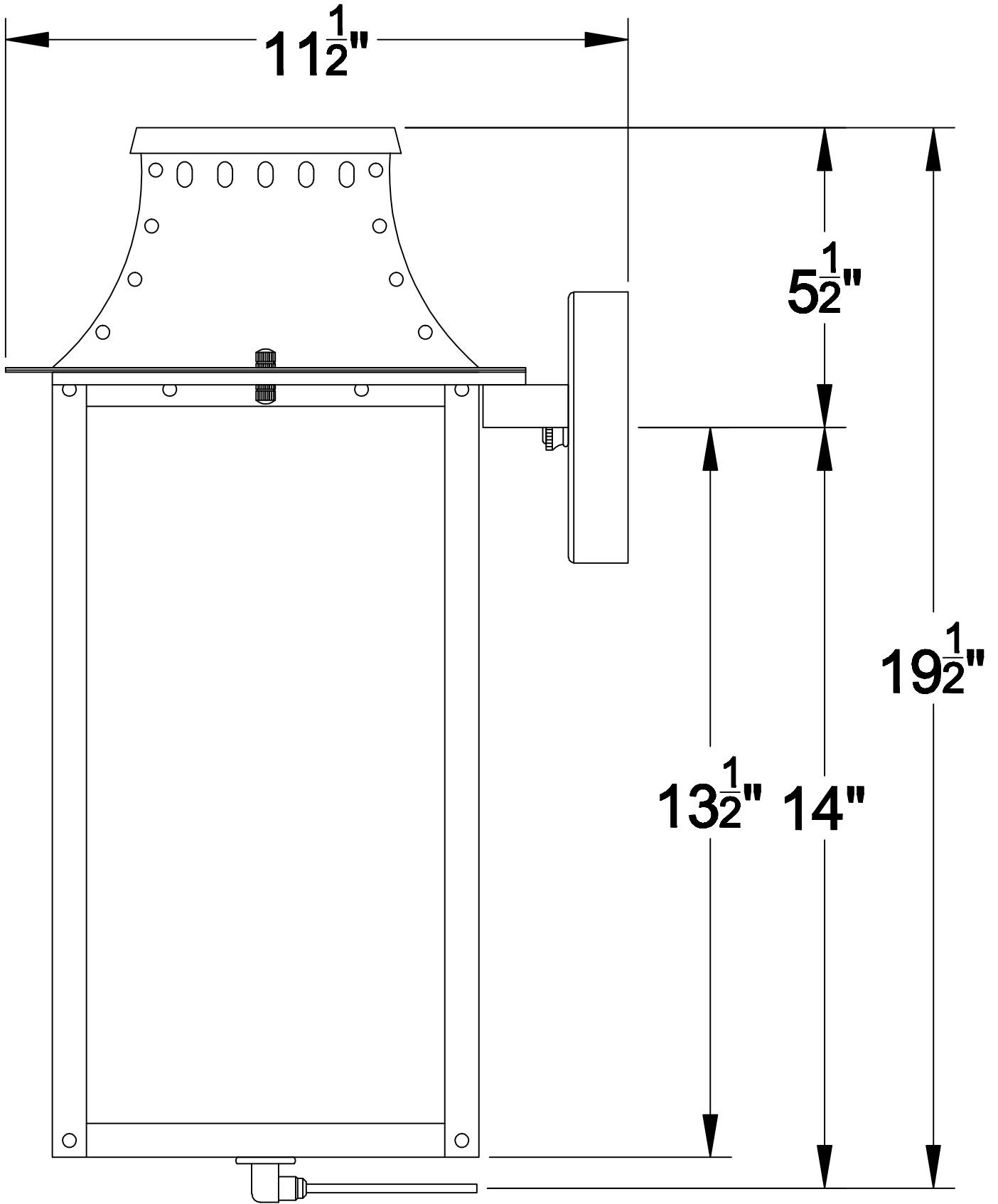

Side

BB-19

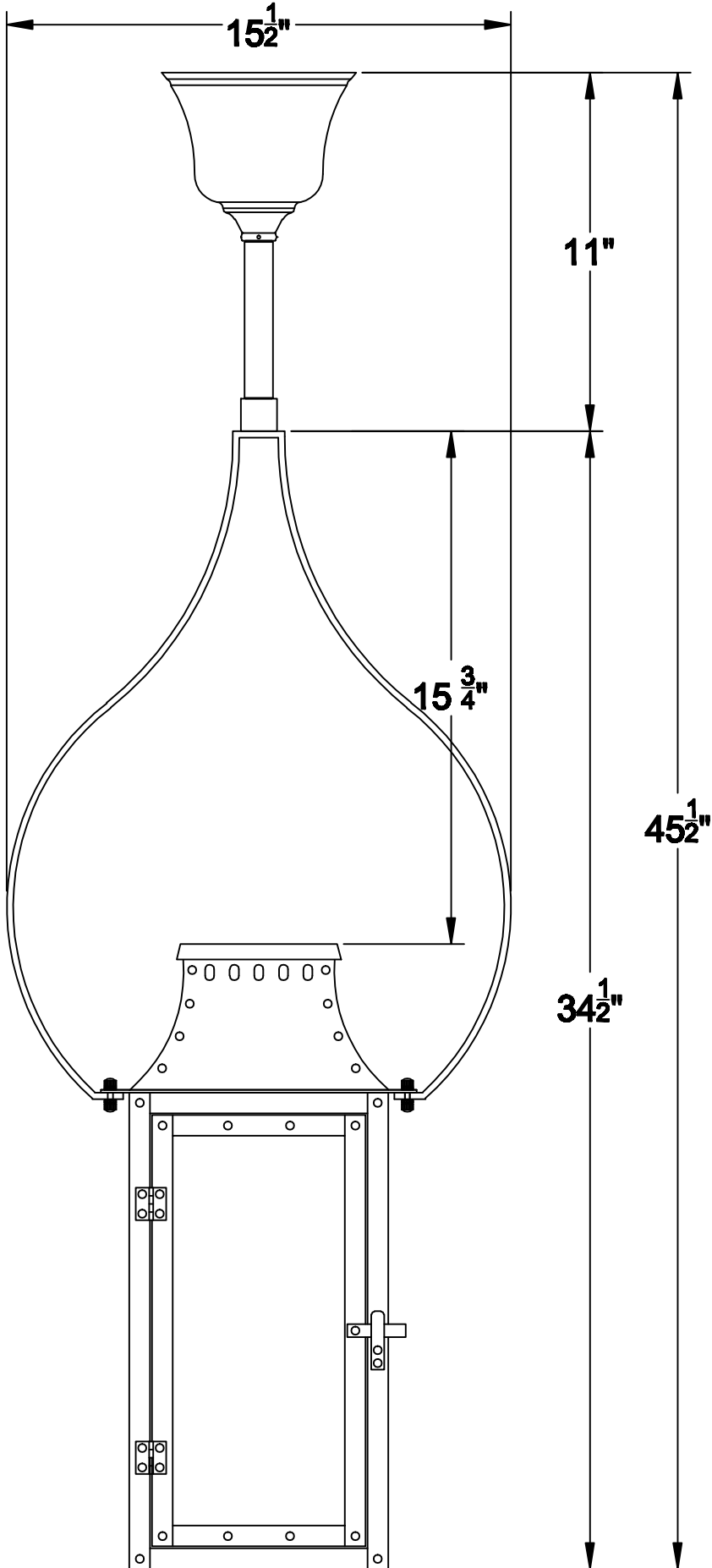

TY-1